

This diagram is provided to assist you to identify parts if replacement is necessary. Contact your place of purchase or the manufacturer to enquire about parts, availability and/or service.

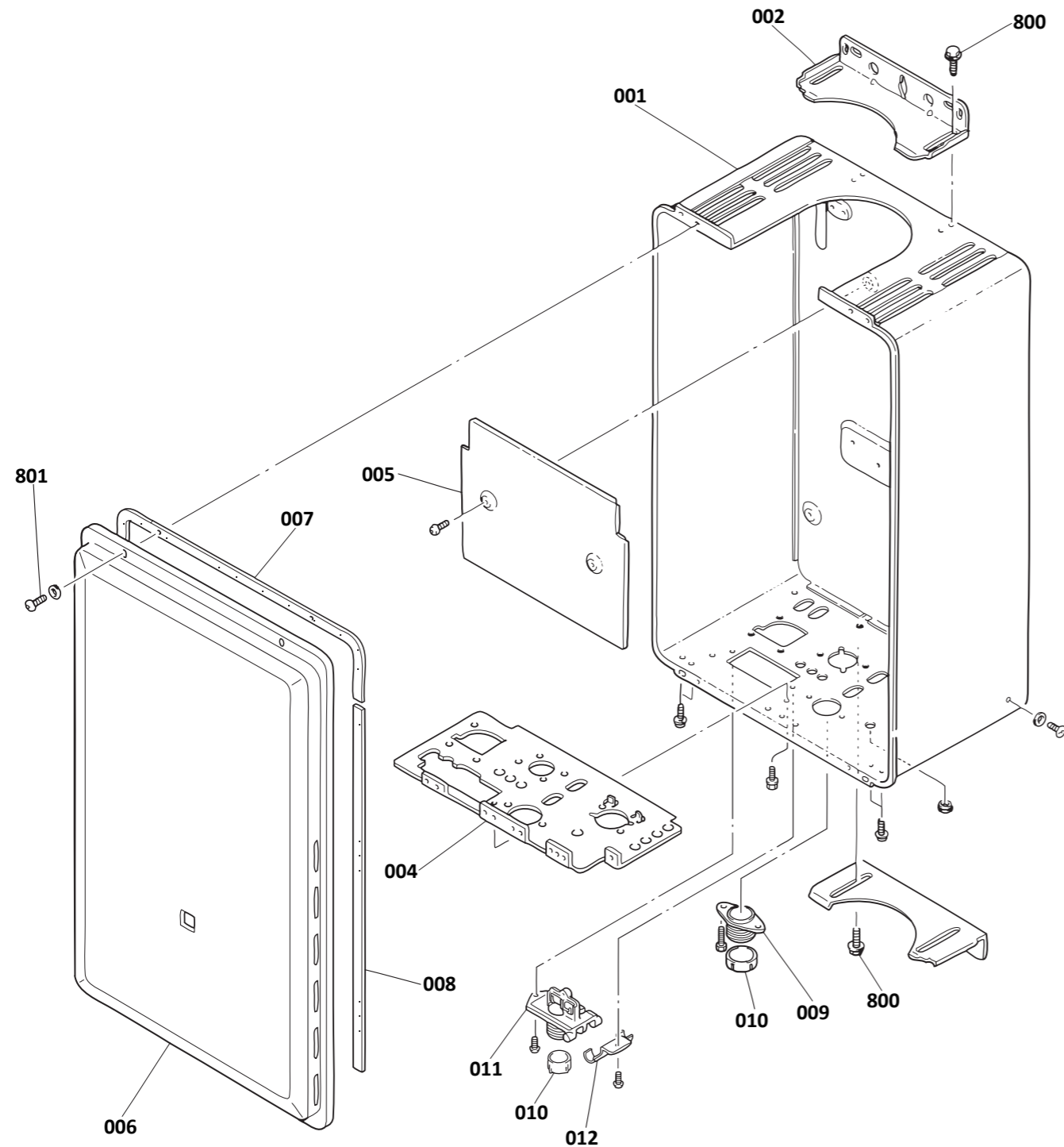

Ref.	Description	Qty.	Part No.
001	Main body assembly	1	Not available
002	Wall bracket Infinity	1	3412
004	Connection reinforcement	1	4917
005	Heat protection plate	1	4933
006	Front panel assembly	1	4915
007	Front panel packing top	1	3418
008	Front panel packing side	1	3807
009	Cable connection	1	3896
010	Cable seal packing	2	2898
011	Quick control connection	1	3310
012	Connection support clip	1	3311
800	Screw	4	4766
801	Screw pack for front panel	1	R5040

This diagram is provided to assist you to identify parts if replacement is necessary. Contact your place of purchase or the manufacturer to enquire about parts, availability and/or service.

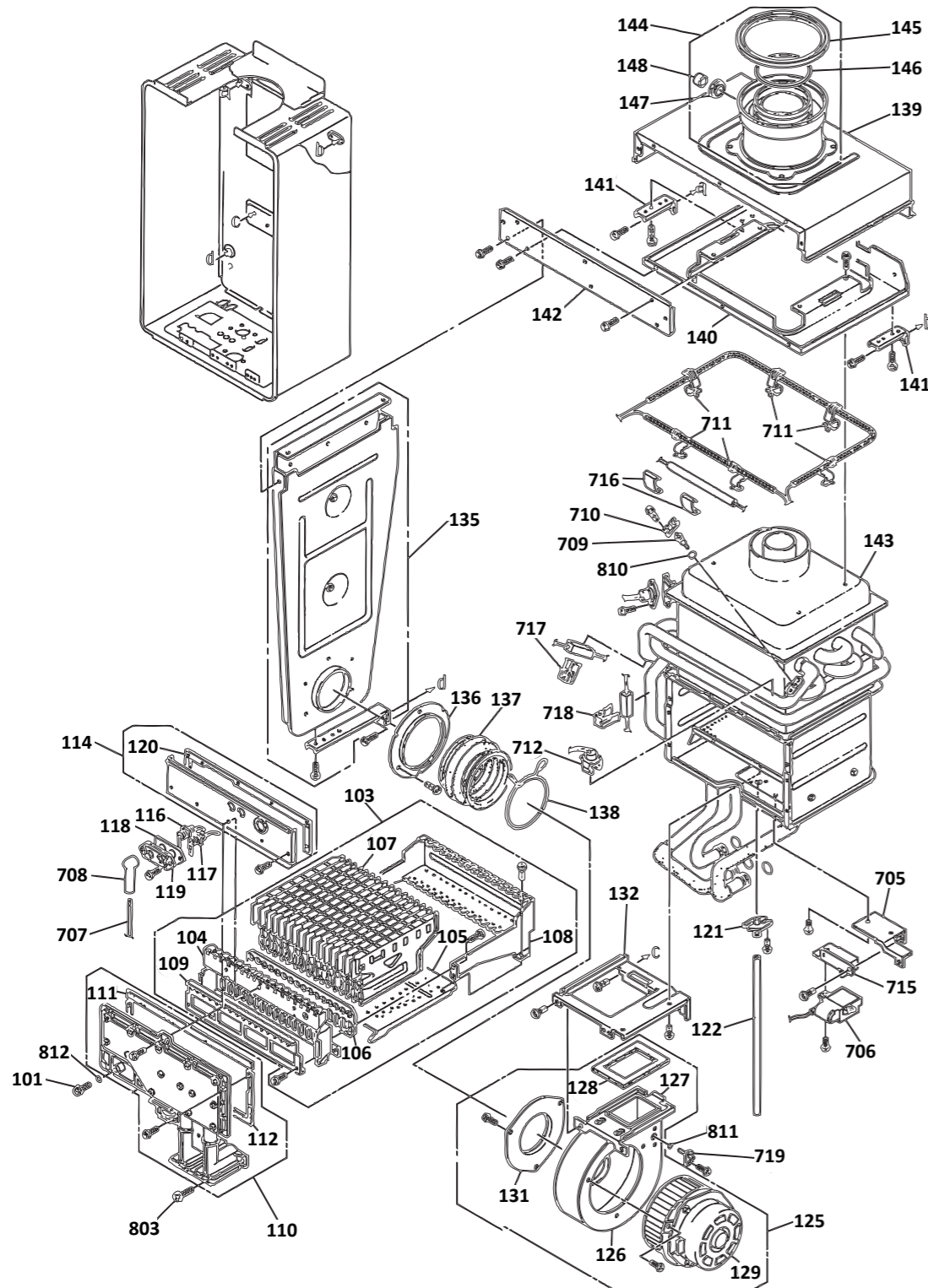

Ref.	Description	Qty.	Part No.
101	Test point screw	1	3564
103	Burner unit assembly NG	1	5337
103	Burner unit assembly LPG	1	3566
104	Burner case front panel	1	4937
105	Burner case bottom plate	1	4938
106	Gasket burner case front	1	4939
107	Lean and rich burner assembly	1	3440
108	Burner case back plate	1	4940
109	Damper LPG	1	3567
109	Damper NG	1	5267
110	Manifold assembly NG	1	4942
110	Manifold assembly LPG	1	4941
111	Combustion chamber packing	1	3589
112	Sealing lower combustion chamber	1	3597
114	Front plate combustion chamber assembly	1	4943
116	Electrode	1	3445
117	Flame rod	1	3464
118	Electrode packing	1	3322
119	Electrode holder	1	3468
120	Gasket combust. chamber front panel packing	1	3600
121	Back pressure joint	1	3604
122	Pressure tube C	1	4945
125	Fan motor assembly	1	4898 ¹
126	Fan casing assembly	1	4922
127	Fan connection mouth	1	4948
128	Fan connection packing	1	2669
129	Combustion fan motor	1	4923
131	Joint fixing pipe	1	5215
132	Combust. chamber front bracket	1	5216
135	Air inlet duct assembly	1	5217
136	Joint bracket	1	5218
137	Connecting joint	1	5219
138	Joint fixing bracket	1	5220

Ref.	Description	Qty.	Part No.
139	Air inlet duct assembly	1	4925
140	Joint exhaust tube frame	1	4929
141	Joint exhaust tube frame	2	5223
142	Air inlet box cover	1	4976
143	Heat exchanger assembly	1	5225
143	Heat exchanger assembly (aggressive water unit)	1	5211
144	Flue connection assembly	1	4913
145	Sealing ring	1	4978
146	O-ring	1	4977
147	Pipe seal	1	4979
148	Cap	1	4980
705	PCB fixing plate	1	5231
706	Ignitor assembly	1	2886
707	High tension lead	1	5335
708	Electrode sleeve	1	3475
709	Thermistor-2	1	2885
710	Thermistor clip	1	3882
711	Temperature fuse fixing plate	1	3659
712	Frost sensing switch	1	3675
715	Ignitor fixing plate	1	5345
716	Anti-frost heater clip	2	3891
717	Heater fixing plate A	1	3917
718	Heater fixing plate B	1	2032
719	Air thermistor	1	5234
725	Thermal fuse assembly	1	4981
727	Ignitor harness	1	5240
729	Remote control harness	1	2891
803	Screw	1	2938
810	O-ring	1	3832
811	O-ring (P3)	1	2974
812	O-ring (S4)	3	2239

Please note: 4898 is also the fan motor assembly for the REU-VRM2632FFUC. This was a short-term interim model.

This diagram is provided to assist you to identify parts if replacement is necessary. Contact your place of purchase or the manufacturer to enquire about parts, availability and/or service.

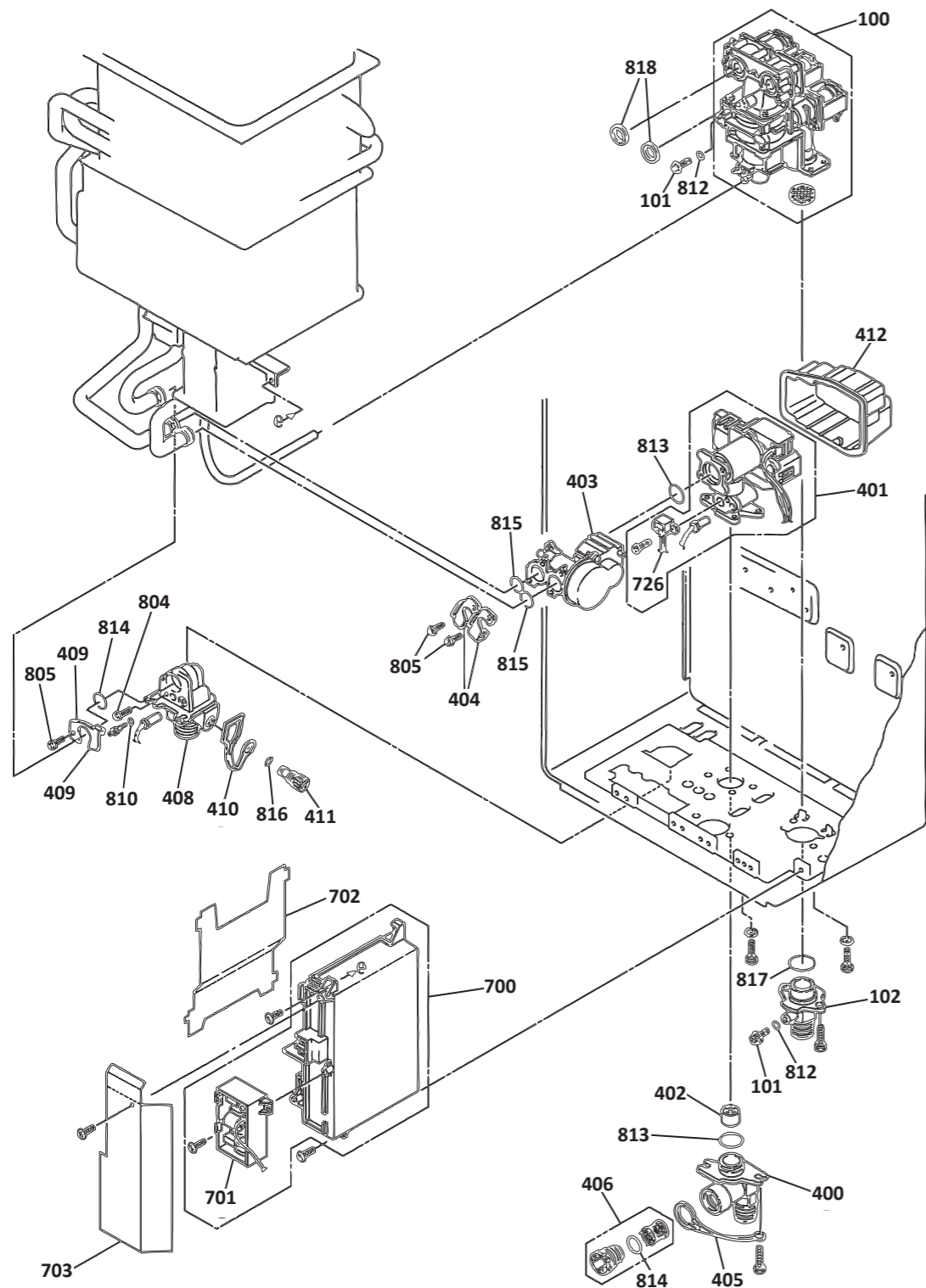

Ref.	Description	Qty.	Part No.
100	Gas control assy	1	4936
101	Test point screw	1	3564
102	Gas connection $\frac{3}{4}$	1	3074
400	Water inlet $\frac{3}{4}$	1	3484
401	Water servo and sensor	1	5227
402	Flow straightener	1	3487
403	Bypass servo assy	1	3944
404	Fixing bracket	1	3624
405	Plug band inlet	1	2927
406	Incoming water filter	1	3839
408	Hot water outlet	1	3625
409	Fixing bracket	1	3645
410	Plug band hot water	1	2926
411	Pressure relief valve	1	3491
412	Water flow servo cover	1	2871
700	PCB main assy	1	5349
701	Surge protector	1	4930
702	Sub circuit board cover	1	5230
703	EC cover 2-Z	1	3950
709	Thermistor 2	1	2885
726	MR sensor	1	5239
804	Thermistor fixing screw	1	3241
805	Screw	2	5244
810	O-ring	2	3832
812	O-ring	3	2239
813	O-ring	2	3627
814	O-ring	2	1244
815	O-ring	2	3826
816	O-ring (P7)	1	1031
817	Gas inlet o-ring	1	3837
818	O-ring gas control	2	3773

This diagram is provided to assist you to identify parts if replacement is necessary. Contact your place of purchase or the manufacturer to enquire about parts, availability and/or service.

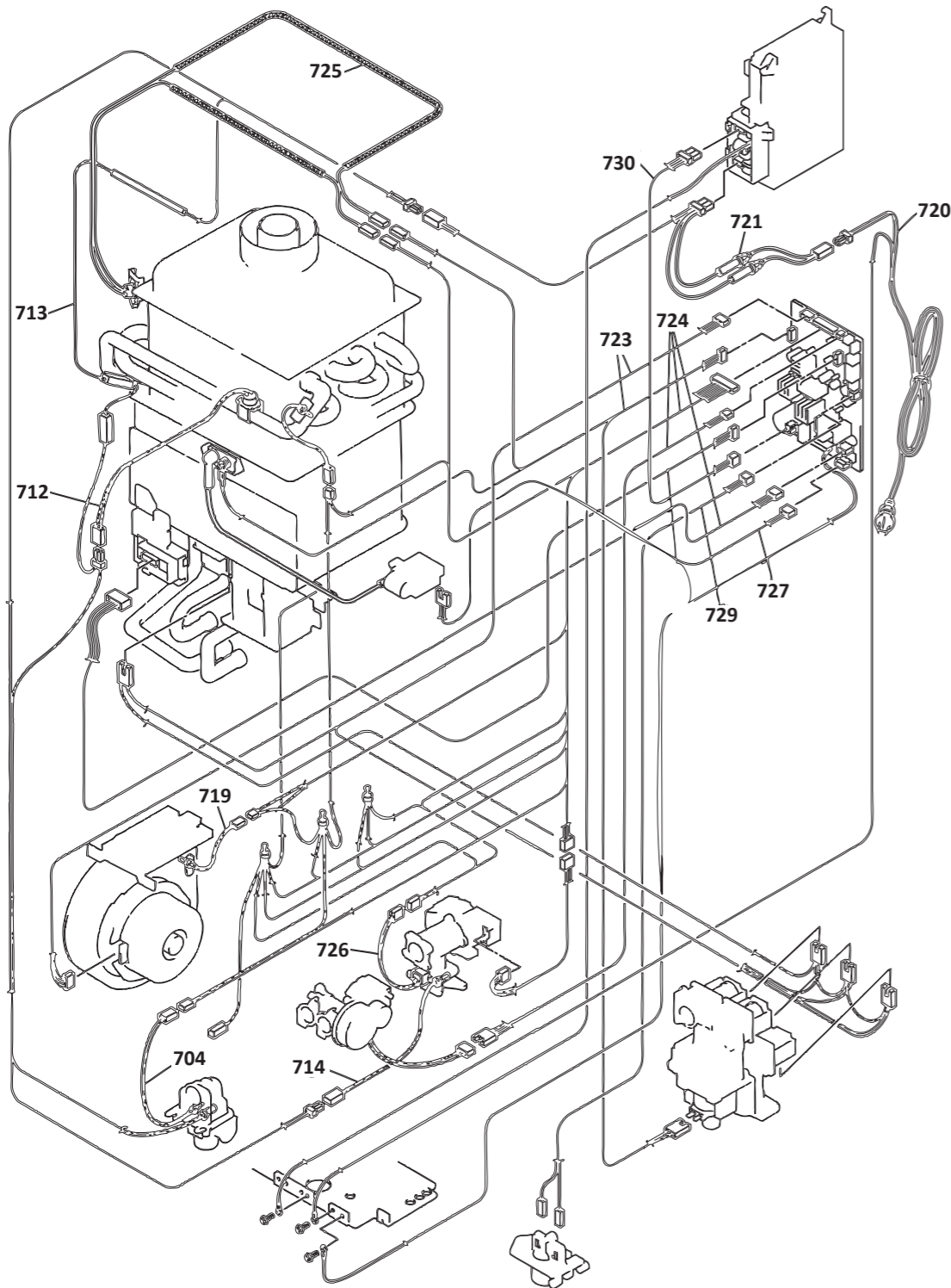

Ref.	Description	Qty.	Part No.
704	Thermistor	1	2884
712	Frost sensing switch	1	3675
713	Heater antifrost assy	1	5233
714	Valve heat assembly	1	4752
719	Air thermistor	1	5234
720	Electric power cord	1	3526
721	Fuse harness	1	5235
723	Harness solenoid valve	1	5236
724	Sensor harness	1	5237
725	Thermal fuse and relay harness	1	3770
726	MR sensor assy	1	5239
727	Harness ignitor	1	5240
729	Remote controller harness	1	2891
730	Electric power harness	1	5241