



M437

M438



M307

M308



M309

M310

M311

Page 1-2

Page 3



CB450
 M100
 M105
 M106



CB452
 CB453
 CB454
 M100
 M105
 M106



M440

M442

M443

M444

Page 4

Page 5

Page 6

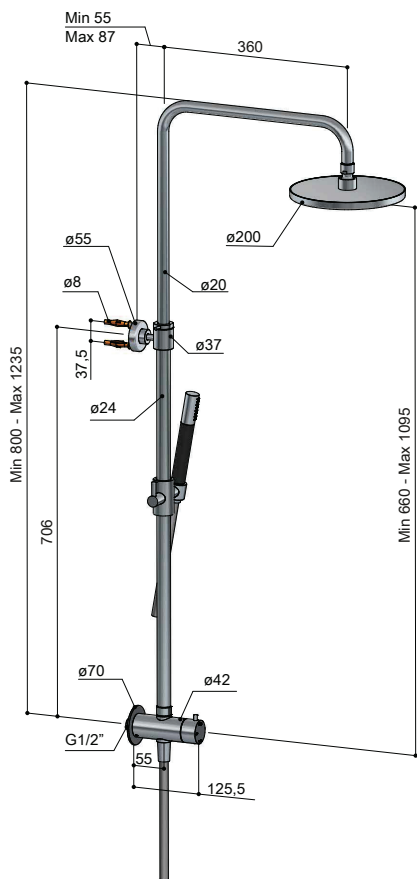

M437

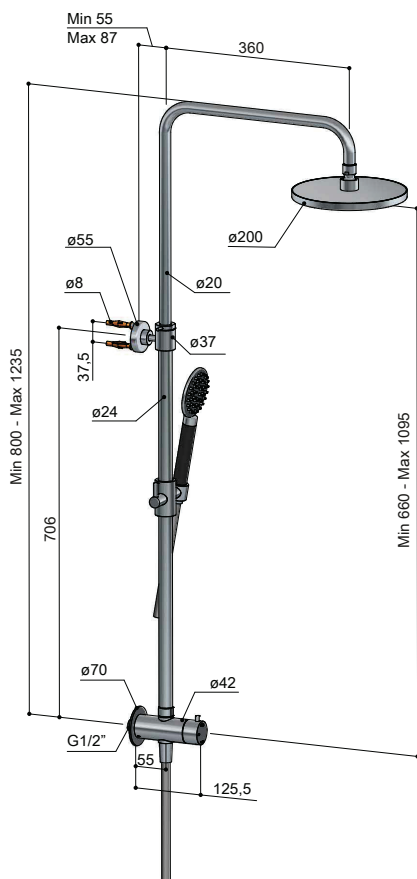

M438

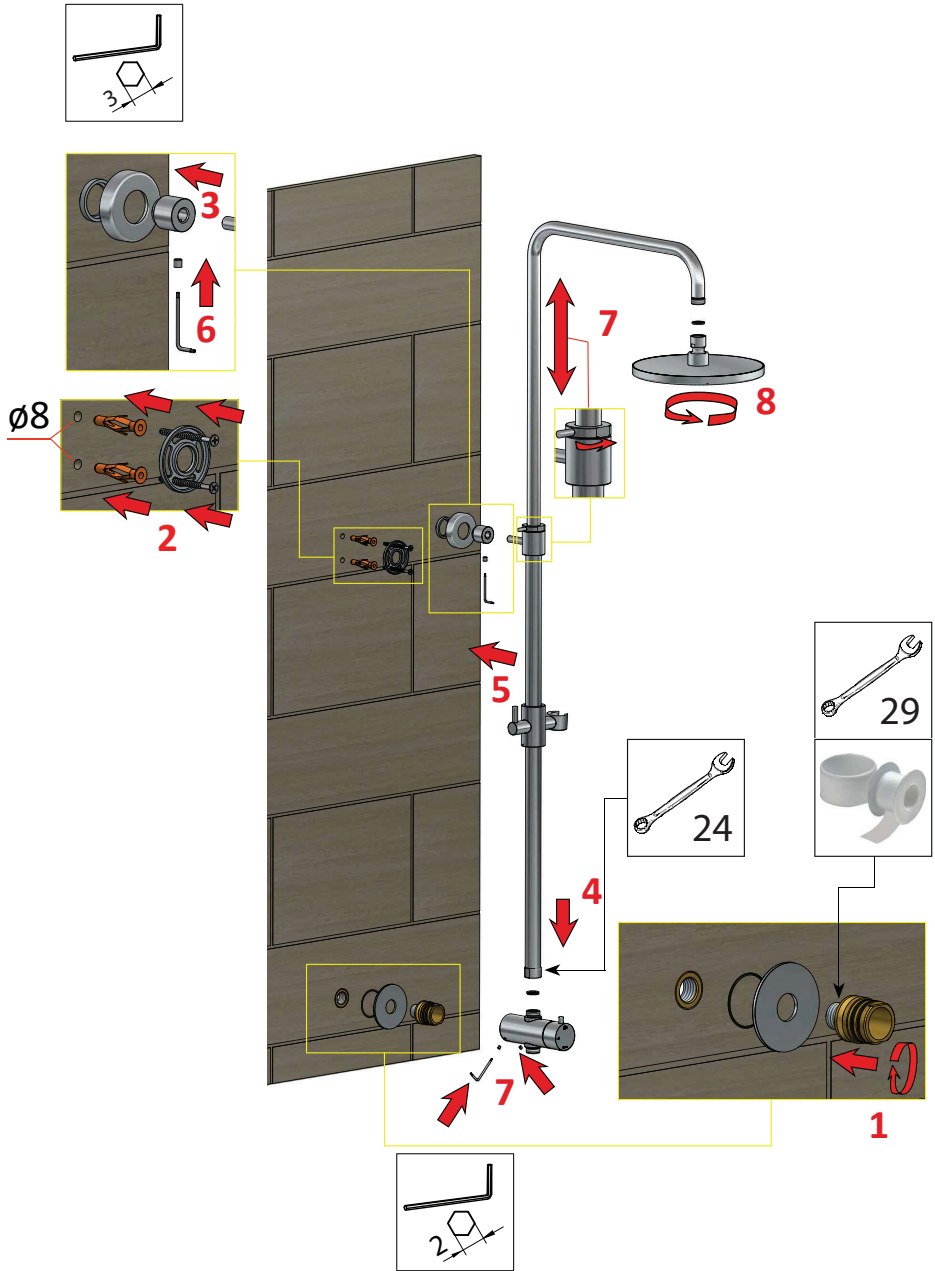

FOR INSTALLATION ABOVE TILES ONLY
 SOLO PER MONTAGGIO SOPRA AL
 RIVESTIMENTO
 SEULEMENT POUR INSTALLATION
 AU-DESSUS DU CARRELAGE
 NUR FÜR INSTALLATION ÜBER FLIESEN

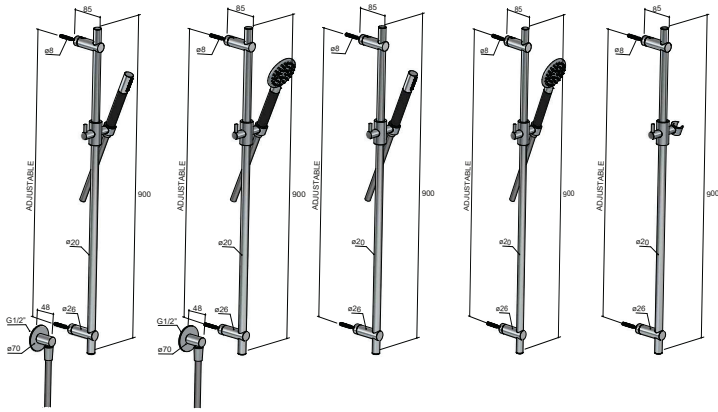

M307

M308

M309

M310

M311

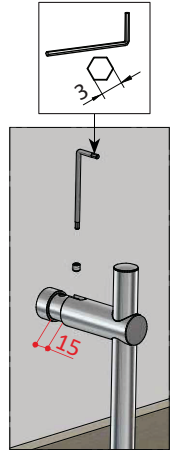

CENTRE DISTANCE 80 CM (FACTORY SETTING) - INTERASSE 80 CM (IMPOSTAZIONE DI FABBRICA)
 ENTRAXE 80 CM (RÉGLAGE USINE) - RADSTAND 80 CM (WERKSEINSTELLUNG)

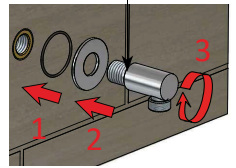
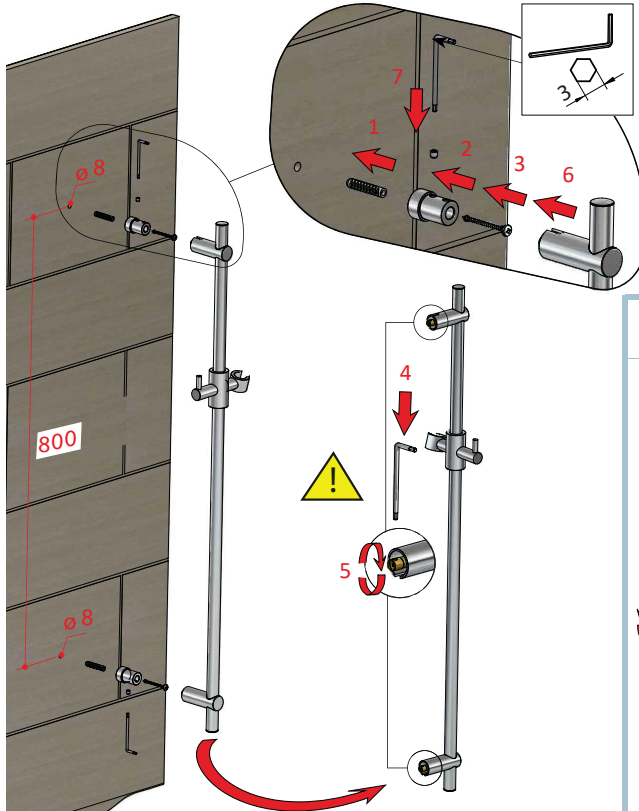

ADJUSTABLE CENTRE DISTANCE
 INTERASSE REGOLABILE
 ENTRAXE REGLABLE
 VERSTELLBARER RADSTAND

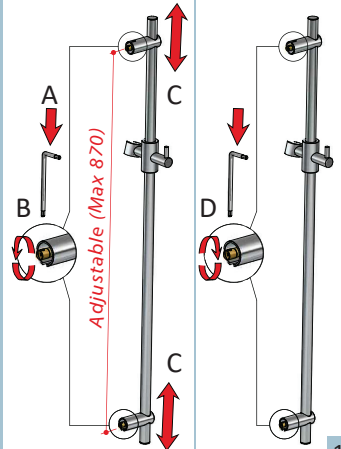

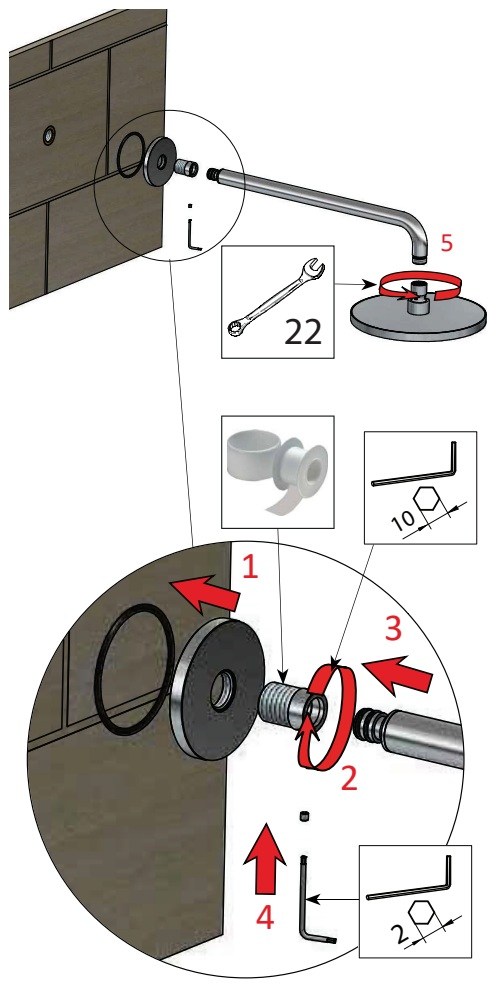
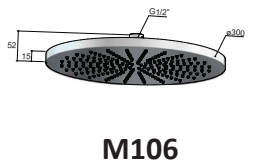
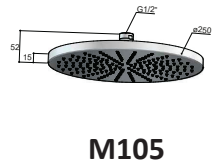
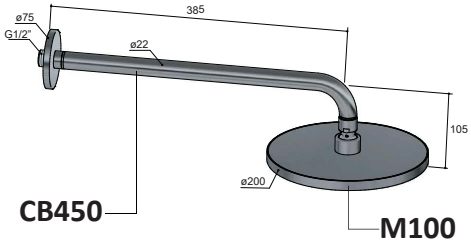



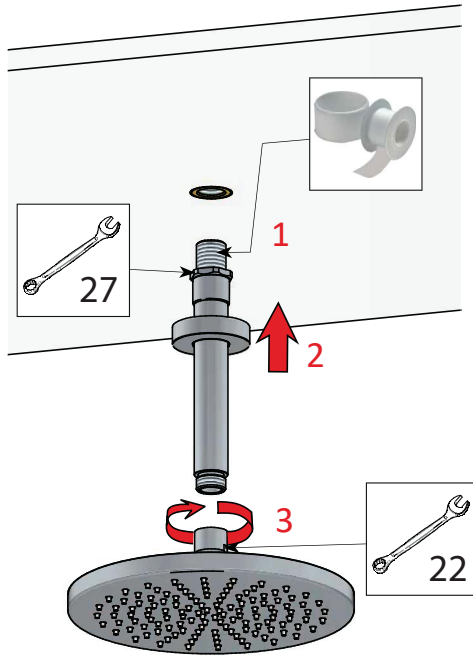
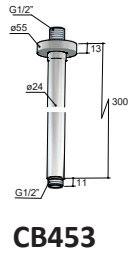
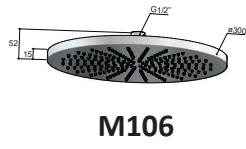
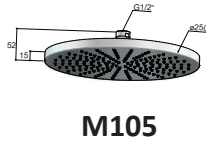

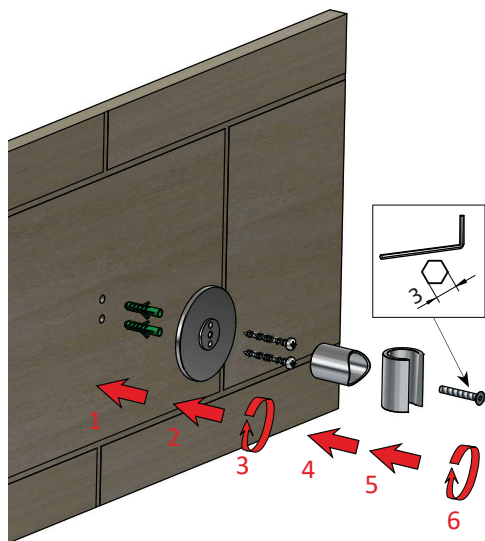
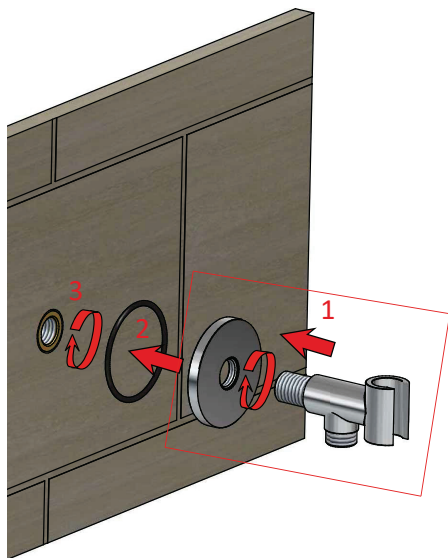
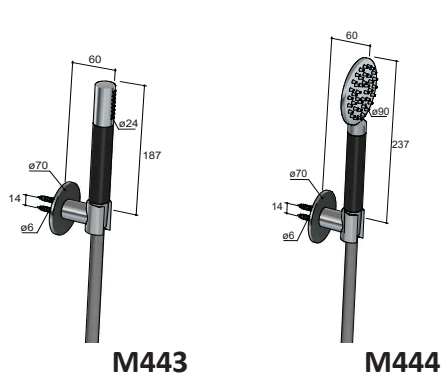
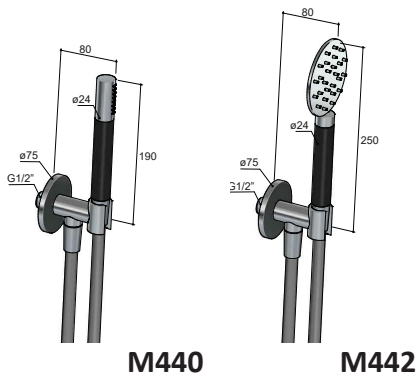

































































































































INSTALLATION





CLEANING

						WARNING
 CHROME	 WATER 	 LIQUID SOAP 	 SMOOTH CLOTH 	 ABRASIVE SPONGE 	 ACID/ABRASIVE DETERGENT 	Inoxidable plated finish
 BRUSHED NICKEL	 WATER 	 LIQUID SOAP 	 SMOOTH CLOTH 	 ABRASIVE SPONGE 	 ACID/ABRASIVE DETERGENT 	Inoxidable plated finish
 BRIGHT NICKEL	 WATER 	 LIQUID SOAP 	 SMOOTH CLOTH 	 ABRASIVE SPONGE 	 ACID/ABRASIVE DETERGENT 	Oxidizable plated finish: patina will form over time
 NATURAL BRASS	 WATER 	 LIQUID SOAP 	 SMOOTH CLOTH 	 ABRASIVE SPONGE 	 ACID/ABRASIVE DETERGENT 	Natural metal finish: patina will form over time
 BRUSHED BRASS	 WATER 	 LIQUID SOAP 	 SMOOTH CLOTH 	 ABRASIVE SPONGE 	 ACID/ABRASIVE DETERGENT 	Natural metal finish: patina will form over time
 AGED BRASS	 WATER 	 LIQUID SOAP 	 SMOOTH CLOTH 	 ABRASIVE SPONGE 	 ACID/ABRASIVE DETERGENT 	Aged metal finish: patina will form over time
 MATT WHITE	 WATER 	 LIQUID SOAP 	 SMOOTH CLOTH 	 ABRASIVE SPONGE 	 ACID/ABRASIVE DETERGENT 	Varnished finish: subject to surface scratches if not properly treated
 BRUSHED COPPER	 WATER 	 LIQUID SOAP 	 SMOOTH CLOTH 	 ABRASIVE SPONGE 	 ACID/ABRASIVE DETERGENT 	Oxidizable plated finish: patina will form over time
 ROSE GOLD	 WATER 	 LIQUID SOAP 	 SMOOTH CLOTH 	 ABRASIVE SPONGE 	 ACID/ABRASIVE DETERGENT 	Plated finish: subject to surface scratches if not properly treated
 MATT BLACK	 WATER 	 LIQUID SOAP 	 SMOOTH CLOTH 	 ABRASIVE SPONGE 	 ACID/ABRASIVE DETERGENT 	Varnished finish: subject to surface scratches if not properly treated
 AGED IRON	 WATER 	 LIQUID SOAP 	 SMOOTH CLOTH 	 ABRASIVE SPONGE 	 ACID/ABRASIVE DETERGENT 	Plated finish: subject to surface scratches if not properly treated
 BLACK CHROME	 WATER 	 LIQUID SOAP 	 SMOOTH CLOTH 	 ABRASIVE SPONGE 	 ACID/ABRASIVE DETERGENT 	Plated finish: subject to surface scratches if not properly treated