

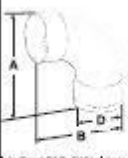

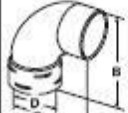

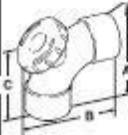





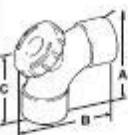

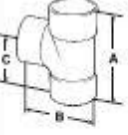

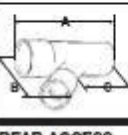
Non Pressure Systems

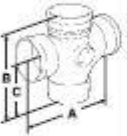
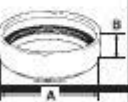
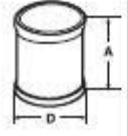

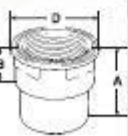



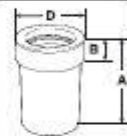

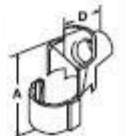
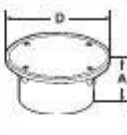
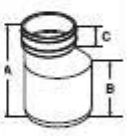
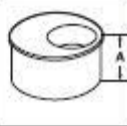

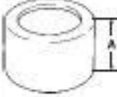

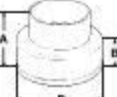
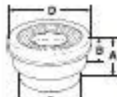
PLAIN BEND F&F	PRODUCT CODE	A	B	C	D
	101-32-15	51.90	62.50		43.10
	101-32-45	67.76	91.46		42.97
	101-32-60	67.50	101.20		43.00
	101-32-68	56.00	89.00		43.00
	101-32-88	87.03	87.03		42.83
	101-40-15	56.00	68.00		48.00
	101-40-45	95.24	96.97		50.00
	101-40-60	97.00	61.50		50.20
	101-40-88	85.20	83.04		47.83
	101-50-15	61.00	77.00		61.00
	101-50-45	114.23	114.23		62.73
	101-50-60	121.00	103.00		63.00
	101-50-68	119.20	104.00		62.40
	101-50-88	101.13	101.13		62.27
	101-65-15	77.00	96.00		75.00
	101-65-45	120.00	105.00		74.00
	101-65-88	126.92	125.37		78.91
	101-80-15	104.00	128.00		92.70
	101-80-45	147.16	142.35		92.97
	101-80-88	143.79	143.79		95.52
101-100-5	123.56	113.46		116.73	
101-100-15	156.00	127.00		123.00	
101-100-45	171.74	171.67		121.38	
101-100-60	220.00	220.00		117.60	
101-100-88	199.15	197.31		119.69	
101-150-45	257.22	255.90		173.61	
101-150-88	292.47	295.82		173.43	
BEND M&F	PRODUCT CODE	A	B	C	D
	171-40-40	64.00	80.00		48.00
	171-50-40	127.00	145.70		77.80
	171-50-85	98.00	101.00		61.00
	171-65-40	98.50	115.00		75.00
	171-80-45	121.00	141.00		93.00
	171-80-88	145.00	140.00		89.00
	171-100-11	151.44	129.67		117.63
	171-100-15	113.00	142.00		122.00
	171-100-22	169.80	167.75		117.77
	171-100-30	113.00	170.00		123.00
	171-100-43	150.00	166.00		117.00
	171-100-88	210.00	201.00		123.00
	REAR ACCESS BEND	PRODUCT CODE	A	B	C
	101-32-88W	86.00	69.00		
	101-40-45W	65.50	92.00		
	101-40-88W	91.00	91.00		
	101-50-45W	110.80	115.00		
	101-50-88W	104.00	103.00		
	101-65-45W	123.00	138.00		
	101-65-85W	126.00	122.00		
	101-80-45W	140.00	141.00		
	101-80-88W	146.00	146.00		
	101-100-45W	154.00	184.00		
101-100-88W	210.00	204.00			
RAMP BEND	PRODUCT CODE	A	B	C	D
	102-100-60S	224.00	200.00	94.00	



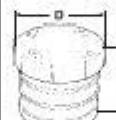
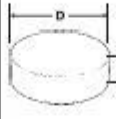

REAR ACCESS	PRODUCT CODE	A	B	C	D
	103-100-88	203.00	225.00	130.00	
SIDE ACCESS	PRODUCT CODE	A	B	C	D
	103-100-45S	249.00	140.00		200.00
	103-100-88S	197.00	147.00		201.00
PLAIN JUNCTION	PRODUCT CODE	A	B	C	D
	104-32-45	116.00	86.00	95.00	
	104-32-88	101.80	86.00	68.00	
	104-40-45	128.00	102.00	101.00	
	104-40-88	122.50	92.93	80.00	
	104-50-45	156.00	123.00	125.00	
	104-50-88	130.00	99.77	102.50	
	104-65-45	184.00	152.50	144.00	
	104-65-85	172.00	145.00	111.00	
	104-80-45	223.13	192.00	213.00	
	104-80-88	186.00	141.00	99.00	
	104-100-45	265.46	230.3	248.57	
	104-100-88	267.35	192.00	197.87	
	104-150-45	395.00	345.00	330.00	
104-150-88	360.00	300.00	210.00		
REDUCING JUNCTION	PRODUCT CODE	A	B	C	D
	104-80-50-45	194.00	166.00	57.00	
	104-100-50-88	165.60	153.00	55.00	
	104-100-50-45	227.00	186.00	72.00	
	104-100-65-45	266.00	191.00	84.00	
	104-100-80-45	266.00	205.00	75.00	
	104-150-100-45 F	330.00	290.00	100.00	
	104-150-100-88 F	320.00	255.00	100.00	
REDUCING JUNCTION	PRODUCT CODE	A	B	C	D
	104-80-50-45 M&F	193.00	168.00	56.00	
	104-150-100-45 M&F	398.00	285.00	280.00	
REAR ACCESS JUNCTION	PRODUCT CODE	A	B	C	D
	105-80-88	186.00	166.95	144.22	112.65
	105-100-88	239.89	245.73	204.61	135.26



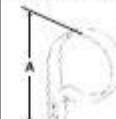

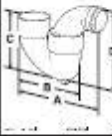
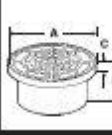

SIDE ACCESS JUNCTION	PRODUCT CODE	A	B	C	D
	105-100-45LH	266.00	252.00		201.00
	105-100-45RH	266.00	252.00		201.00
DOUBLE	PRODUCT CODE	A	B	C	D
	Equal				
	106-100-45	355.00	268.00	218.00	
	106-100-88	259.00	284.00	153.00	
	Reducing				
	106-100-50-45	246.18	194.80	122.00	
RING SEAL ADAPTER	PRODUCT CODE	A	B	C	D
	109-80	100.00	30.50		
	109-100	127.00	38.00		
STRAIGHT COUPLER	PRODUCT CODE	A	B	C	D
	110-32	54.00			43.00
	110-40	61.00			50.00
	110-50	65.50			62.50
	110-65	82.00			75.00
	110-80	94.73			93.00
	110-100	107.83			120.40
	110-150	158.40			175.00
STRAIGHT COUPLER THREADED	PRODUCT CODE	A	B	C	D
	110-100T	103.00			
EXPANSION COUPLER	PRODUCT CODE	A	B	C	D
	111-32	71.00			50.50
	111-40	78.00			57.00
	111-50	81.00			71.00
	111-65	98.00			85.00
	111-80	122.00			106.00
	111-100	127.00			130.00
	111-150	182.00			188.00
FEMALE ADAPTER	PRODUCT CODE	A	B	C	D
	112-32	51.00	25.30		53.74
	112-40	54.00	25.30		60.00
	112-50	48.00	17.00		70.00
	112-65	73.00	34.00		84.00

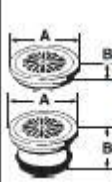





MALE ADAPTER	PRODUCT CODE	A	B	C	D
	113-32	47.00	28.00		53.50
	113-40	51.00	32.00		60.00
	113-50	54.00	36.00		74.50
	113-65	74.00	43.50		80.00
	113-80	80.50	50.00		89.24
113-100	111.00	70.00		145.75	
COPPER TO PVC CONNECT	PRODUCT CODE	A	B	C	D
	114-32	71.00	17.00		50.50
	114-40	78.00	17.00		56.00
	114-50	84.00	17.00		70.00
EXPANSION STRAP BOSS	PRODUCT CODE	A	B	C	D
	(bolted)				
	119-80-50	102.00	105.60		70.50
	119-100-50	101.50	105.00		70.50
STRAP BOSS (solvent)	PRODUCT CODE	A	B	C	D
	119-80-50S	100.00			122.00
	119-100-50S	101.00			149.00
	119-100-65S	193.00			130.00
SEALED CLEAN OUT	PRODUCT CODE	A	B	C	D
	120-80	57.50			126.50
	120-100	67.00			168.00
LEVEL INVERT REDUCER	PRODUCT CODE	A	B	C	D
	123-40-32	63.00	28.00	30.00	
	123-50-32	89.00	32.00	30.00	
	123-50-40	80.30	32.00	31.00	
	123-65-40	100.00	38.00	31.00	
	123-65-50	90.00	40.20	33.80	
	123-80-50	105.00	46.00	33.50	
	123-80-65	100.00	47.00	41.00	
	123-100-50	150.00	52.00	34.00	
	123-100-65	142.00	63.00	41.50	
	123-100-80	135.00	62.00	47.30	
	123-150-100	234.00	121.00	53.00	
PIPE REDUCING BUSH	PRODUCT CODE	A	B	C	D
	198-100-40	56.70			
	198-100-50	56.70			





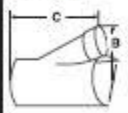

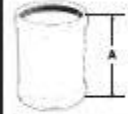
SOCKET REDUCING BUSH	PRODUCT CODE	A	B	C	D
	124-40-32	29.10			
	124-50-32	31.50			
	124-50-40	31.80			
	124-65-40	39.00			
	124-65-50	41.80			
	124-80-50	38.50			
	124-80-65	46.00			
	124-100-40	57.00			
	124-100-50	53.00			
	124-100-65	50.00			
	124-100-80	53.00			
124-150-100	78.30				
PVC-CERAMIC ADAPTER	PRODUCT CODE	A	B	C	D
	124-100S	54.29			138.23
CERAMIC-PVC ADAPTER	PRODUCT CODE	A	B	C	D
	125-100S	112.00	63.00		171.00
PAN (M&F) CONNECTOR	PRODUCT CODE	A	B	C	D
	127-80	130.00	61.00		154.20
	127-100	107.80	56.70		154.30
	<u>Offset</u> 127M-100	114.00	25.00		153.00
	<u>Concentric</u> 127C-100	99.00	52.50	103.00	153.00
	INSPECTION PIPE M&F	PRODUCT CODE	A	B	C
	129-100S	295.00	156.00		201.00
FLASHING CONE	PRODUCT CODE	A	B	C	D
	131-32	57.00	41.00		
	131-40	56.70	41.00		
	131-50	66.00	40.50		
	131-65	68.00	46.00		
	131-80	87.00	54.00		
	131-100	92.00	66.00		
	131-150	83.00	53.70		

ACCESS PLUG (spigot end)	PRODUCT CODE	A	B	C	D
	136-32	42.50			55.00
	136-40	45.00			55.00
	136-50	48.00			70.00
	136-80	30.00			113.00
	136-100	36.00			144.00
SCREW CAP & BASE (socket end)	PRODUCT CODE	A	B	C	D
	136-100S	121.88			136.00
	136-100 (cap)	35.00			134.00
	136-150S	175.00			188.00
	136-150 (cap)	35.00			187.00
PUSH ON CAP	PRODUCT CODE	A	B	C	D
	137-32	17.00			38.00
	137-40	19.00			46.00
	137-50	24.00			58.00
	137-65	22.00			75.00
	137-80	25.00			88.50
	137-100	25.00			116.00
	137-150	41.95			169.10
PIPE CLIP SADDLE	PRODUCT CODE	A	B	C	D
	140-32	74.70			49.00
	140-40	87.00			53.00
	140-50	98.00			67.00
	140-80	114.00			117.00
	140-100	158.00			142.00
2 PART HOLDER BAT	PRODUCT CODE	A	B	C	D
	140-80HB	143.00			111.40
	140-100HB	173.00			140.00
	140-150HB	220.00			188.00
PIPE CLIP STAND OFF	PRODUCT CODE	A	B	C	D
	140-32S	80.00	91.00		
	140-40S	88.00	90.00		
	140-50S	100.00	96.00		
	140-65S	98.00	139.00		
	140-80S	145.00	133.00		
	140-100S	180.00	155.00		
PIPE CLIP SIDE HANGAR	PRODUCT CODE	A	B	C	D
	140-80H	141.00			
	140-100H	178.00			

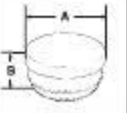

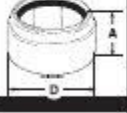
VENT COWL	PRODUCT CODE	A	B	C	D	
	150-50-40	80.00				
	150-65	71.50				
	150-80	100.00				
	150-100	90.00				
ADJUSTABLE FLOOR WASTE GULLY	PRODUCT CODE	A	B	C	D	
	159-80-50P	247.00	193.00	155.00	230.00	
	159-80-65P	260.00	193.00	150.00	230.00	
	159-100-100P	276.00	231.00	170.00	290.00	
	<i>Fixed Position</i> 159-80-80P	300.00	220.00	158.00	250.00	
ADJUSTABLE-INSPECTION FLOOR WASTE GULLY	PRODUCT CODE	A	B	C	D	
	159-80-50PW	246.00	194.00	178.00	245.00	
	159-80-65PW	235.00	169.00	121.00	220.00	
GULLY CELLAR & GRATE	PRODUCT CODE	A	B	C	D	
	<i>Loose Fit Top</i> 168-100	149.00	67.00	15.00		
	<i>Fixed pop up top</i> 168-100POP	150.30	133.00	37.50		
FLOOR GRATE VINYL FLOORS	PRODUCT CODE	A	B	C	D	
	<i>Chrome plated brass</i> 168-80-RCP	92.00	43.60			
	168-100-RCP	122.00	50.00			
	<i>White PVC</i> 168-80RAM	93.50	17.00			
	168-100RAM	117.80	17.60			
FLOOR GRATE TILE FLOORS	PRODUCT CODE	A	B	C	D	
	<i>Round (white PVC)</i> 168-80R	100.00	60.00			
	169-100R	117.80	72.50			
	<i>Bevelled (white PVC)</i> 169-80	100.00	60.00			
	169-100	130.00	70.00			
	<i>SQ chrome plated brass</i> 169-80SCP	94.00	44.00			
	169-100SCP					

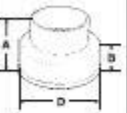
4 WAY BOSS JUNCTION M&F	PRODUCT CODE	A	B	C	D
	170-80-50-40-88	164.00	143.00	86.00	
	170-100-50-40-88	182.00	175.00	101.00	
	170-100-80-50-40	175.50	174.00	112.50	
PLAIN BEND F&F	PRODUCT CODE	A	B	C	D
	1501-100-45	196.00	171.00		127.00
	1501-100-60	238.00	245.00		133.50
	1501-100-88	214.00	214.00		128.00
	1501-150-45	260.00	230.00		183.00
	1501-150-88	300.00	300.00		183.00
M&F SPIGOT BEND	PRODUCT CODE	A	B	C	D
	1571-100-5	148.00	158.00		130.00
	1571-100-11	142.00	163.00		132.00
	1571-100-15	154.00	183.00		130.00
	1571-100-22	136.00	183.00		133.00
	1571-100-30	196.00	199.00		130.00
	1571-150-15	209.00	247.00		188.00
ADJUSTABLE BEND	PRODUCT CODE	A	B	C	D
	1501-150A	269.00	269.00		
RAMP BEND	PRODUCT CODE	A	B	C	D
	1502-100-60	250.00	150.00		
	1502-100-88	244.64	180.00		
SIDE ACCESS BEND	PRODUCT CODE	A	B	C	D
	1503-100-45	254.00	145.00	190.00	
	1503-100-88	211.50	145.00	148.00	
PLAIN (F&F) JUNCTION	PRODUCT CODE	A	B	C	D
	1504-100-45	292.50	275.00	238.50	128.00
	1504-100-88	264.70	218.00	213.00	127.00
	1504-100-45-F	390.00	390.00	355.00	183.00
	1504-100-88F	350.00	270.00	295.00	183.00
	<i>Reducing</i> 1504-150-100Y	390.00	280.00	300.00	183.00

PLAIN JUNCTION	PRODUCT CODE	A	B	C	D
 (spigot end)	1504-150-45	435.00	295.00		160.00
	1504-150-88	435.00	270.00		160.00
LORDEN JUNCTION	PRODUCT CODE	A	B	C	D
 (spigot end)	1504-100-LJ	740.00	230.00	500.00	
	1504-150-LJ	698.00	240.00	520.00	
	<i>Heavy duty</i> Z1505H-150-LJ	740.00	230.00	500.00	
	Z1504H-150-100LJ	698.00	240.00	520.00	
PVC-PVC REDUCING SADDLE	PRODUCT CODE	A	B	C	D
	1504S-150-100	365.00	210.00	280.00	
SIDE ACCESS JUNCTION	PRODUCT CODE	A	B	C	D
	1505-100-45LH	292.00	127.80	245.00	
	1505-100-45RH	292.00	127.80	245.00	
COMBINATION STANDARD/SLIP COUPLER	PRODUCT CODE	A	B	C	D
	1511-100C	160.00			
	1511S-150	236.00			
RING SEAL COUPLER	PRODUCT CODE	A	B	C	D
	1511-150	235.00			
	<i>Heavy duty</i> Z1511H-150	235.00			
SEP TO TANK JUNCTION	PRODUCT CODE	A	B	C	D
	1514-100-88	665.00	210.00		

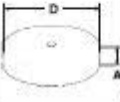
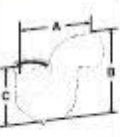
FRESH AIR INLET	PRODUCT CODE	A	B	C	D
	1516-100	152.00	102.00		
LEVEL INVERT REDUCER	PRODUCT CODE	A	B	C	D
	1523-100-80	135.00	62.00	47.30	
	1523-150-100	222.00	98.00	65.00	
PVC-CERAMIC ADAPTER	PRODUCT CODE	A	B	C	D
	1524-100	73.00			137.00
	1524-150	263.00			192.00
PRESSURE/SEWER ADAPTER	PRODUCT CODE	A	B	C	D
	1524-114-100	123.00			
CERAMIC-PVC ADAPTER	PRODUCT CODE	A	B	C	D
	125-100S	112.00	63.00		171.00
ACCESS PIPE M&F	PRODUCT CODE	A	B	C	D
	1529-100	305.00	152.00	140.00	201.00
	1529-150	415.00	209.00	260.00	186.00
SOCKET PLUG	PRODUCT CODE	A	B	C	D
	1530-100	88.00	72.00		

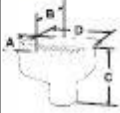
PUSH ON CAP	PRODUCT CODE	A	B	C	D
	137-100	25.00			117.00
	137-150	42.00			170.00
GULLY TRAP	PRODUCT CODE	A	B	C	D
	1559-100	330.00	300.00	220.00	

GULLY DISH	PRODUCT CODE	A	B	C	D
	<u>Complete</u>				
	1575-100	214.00	135.00	252.00	300.00
	<u>Lid only</u>				
	1575L-100	199.00	120.00		284.00
GULLY RISER	PRODUCT CODE	A	B	C	D
	1575R-100-100	100.00			
	1575R-100-200	200.00			
	1575R-100-300	300.00			

FWG INSTALLATION DETAIL

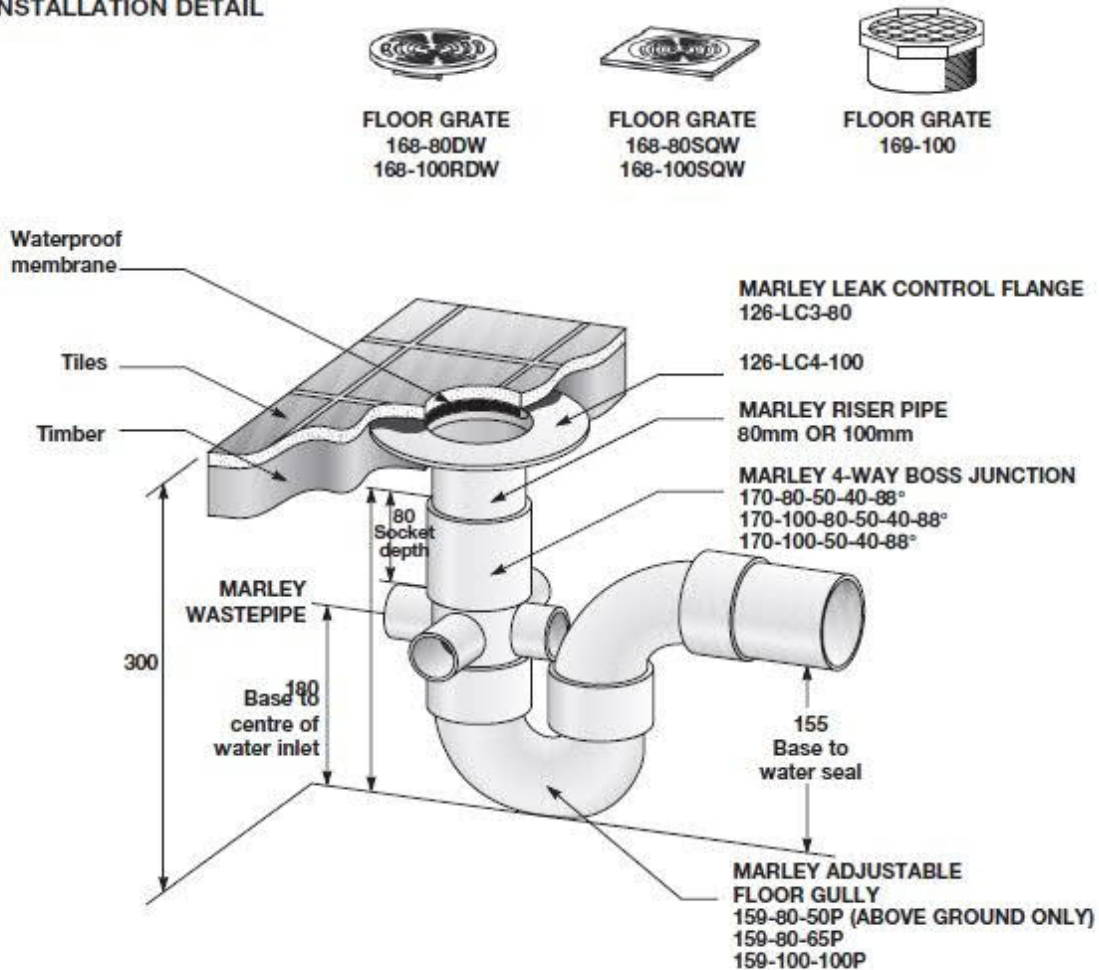

REDI STORMWATER LARGE DIAMETER FITTINGS



REDI STORMWATER LARGE DIAMETER FITTINGS

Plain Bend 45° (F & F)

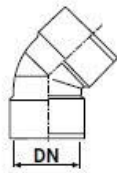

CODE	PIPE SIZE	DN (ID)	ANGLE
701M.175.45	175	200	45°
701M.225.45	225	250	45°
701M.300.45	300	315	45°

Plain Bend 90° (F & F)

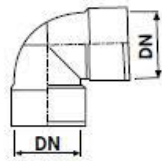

CODE	PIPE SIZE	DN (ID)	ANGLE
701M.175.90	175	200	88°
701M.225.90	225	250	88°
701M.300.90	300	315	88°

Plain Junction 45° (F & F)

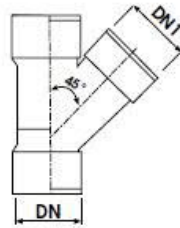

CODE	PIPE SIZE	DN (ID)	DN1 (ID)	ANGLE
704M.175.45	175 x 175	200	200	45°
704M.225.45	225 x 225	250	250	45°
704M.300.45	300 x 300	315	315	45°

All dimensions in millimeters

Plain Junction 90° (F & F)



CODE	PIPE SIZE	DN (ID)	DN1 (ID)	ANGLE
704M.175.90	175 x 175	200	200	88°
704M.225.90	225 x 225	250	250	88°
704M.300.90	300 x 300	315	315	88°

Reducing Junction 45° (M & F)

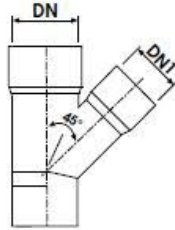

CODE	PIPE SIZE	DN (ID)	DN1 (ID)	ANGLE
704M.175.100.45MF	175 x 100	200	110	45°
704M.175.150.45MF	175 x 150	200	160	45°
704M.225.150.45MF	225 x 150	250	160	45°
704M.225.175.45MF	225 x 175	250	200	45°

Reducing Junction 90° (F & F, M & F)



CODE	PIPE SIZE	DN (ID)	DN1 (ID)	ANGLE
704M.175.150.90FF*	175 x 150	200	160	88°
704M.175.150.90MF	175 x 150	200	160	88°

All dimensions in millimeters

Slip Coupler

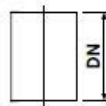

CODE	PIPE SIZE	DN (ID)
710M.175	175	200
710M.225	225	250
710M.300	300	315

Level Invert Reducer

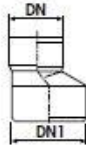

CODE	PIPE SIZE	DN (ID)	DN1 (ID)
723M.150.100	150 x 100	160	110
723.175.100*	175 x 100*	200	110
723M.175.150	175 x 150	200	160
723M.225.100	225 x 100	250	110
723M.225.150	225 x 150	250	160
723M.225.175	225 x 175	250	200
723M.300.150	300 x 150	315	160
723M.300.175	300 x 175	315	200
723M.300.225	300 x 225	315	250

Female End Cap

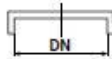

CODE	PIPE SIZE	DN (ID)
737M.175	175	200
737M.225	225	250
737M.300	300	315

All dimensions in millimeters